



M1577541A

ITEM NUMBERS: 1577541,
1577542

Owner's Manual

Pressure Washer: Machine that cleans dirty surfaces with high pressure water.

	<p style="text-align: center;">⚠ WARNING</p> <p>Read this manual. Serious injury or death can result if safety instructions are not followed.</p>
--	---

	<p>Engine is shipped without oil.</p> <ul style="list-style-type: none">- Before starting engine, fill engine oil.- See engine manual for engine oil requirements. <p>Pump is shipped with oil.</p> <ul style="list-style-type: none">- Remove shipping plug and install vented fill cap.- See pump oil cap section of this manual. <p>Closely inspect all components.</p> <ul style="list-style-type: none">-If you have damaged components then: Contact the freight company that delivered the unit and file a claim.-If you have missing components then: Contact Customer Service at 1-800-270-0810.
--	---

fig0187b

Any Questions, Comments, Problems or Parts Orders

Call NorthStar Customer Service 1-800-270-0810

Hazard Signal Word Definitions







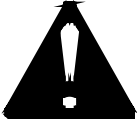

	<p>This is the safety alert symbol. It is used to alert you to potential personal injury hazards. Obey all safety messages that follow this symbol to avoid possible injury or death.</p>
	<p>DANGER (red) indicates an imminently hazardous situation which, if not avoided, will result in death or serious injury.</p>
	<p>WARNING (orange) indicates a potentially hazardous situation which, if not avoided, could result in death or serious injury.</p>
	<p>CAUTION (yellow) indicates a potentially hazardous situation which, if not avoided, may result in minor or moderate injury.</p>
	<p>CAUTION (yellow) used without the safety alert symbol indicates a potentially hazardous situation which, if not avoided, may result in property damage.</p>

fig01453

Table of Contents

▲ Important Safety Rules	4,5
▲ Warning Label Locations	6
Assembly Instructions.....	7-11
Machine Component Identification.....	12
Pump Oil Cap and Pump Component Identification...	13
▲ Operation Instructions	13-17
Water Supply.....	13
Start-Up/Shut-Down Instructions.....	14
Spray Gun Safety Lock.....	15
Attaching the Lance.....	15
Installing Nozzles.....	16
Quick Connect hoses.....	16
Applying Chemicals.....	17
▲ Maintenance.....	18,19
Maintenance Mode.....	18
Maintenance Schedule.....	18
Pump Oil Change.....	19
▲ Storage.....	19
Long Term Storage.....	19
Winter Storage.....	19
Troubleshooting	20
Specifications	20
Parts Explosions	21

▲ Important Safety Rules

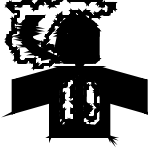
▲ WARNING	
	<p>1.) Read owner's manual completely. Serious injury or death can result if safety instructions are not followed. You must be 16 or older to operate this machine. Keep untrained people away.</p>
	<p>2.) Skin puncture hazard. High pressure fluid can inject under skin resulting in serious injury including amputation. Do not direct spray at people or animals. -If skin injection happens, seek IMMEDIATE surgical treatment. -Do not check for leaks with hand. Instead, use a piece of cardboard to check for leaks. -Do not use unit if exterior hose damage is evident. Make sure all fittings are tight before starting. Relieve system pressure before servicing. -Know how to stop engine and bleed pressures quickly. Be thoroughly familiar with the controls. -Make sure accessories meet the unit's temperature and pressure limits. -Stop engine, bleed pressure, and engage spray gun safety lock before leaving unit unattended.</p>
	<p>3.) Risk of fire and explosion. Hot exhaust fumes from engine can cause fire. Gasoline is highly flammable and explosive. You can be burned or seriously injured when handling fuel. -Position muffler at least 7 feet from combustible objects. -Before adding fuel, stop the engine and keep heat, sparks, and flame away. Do not add fuel when engine is running or still hot. No smoking near engine. -Do not pump fuel directly into engine at gas station. Static charge can build and ignite fuel. Use a UL approved fuel container to transfer gas to the engine. Wipe up fuel spills immediately. -Only store and handle fuel outdoors. Gasoline vapors can ignite if they collect inside an enclosure. Explosion can result. -Do not change or add to exhaust system. Fire can result. -Do not change or add fuel tanks or fuel lines. Fire can result. -Before each use, check fuel tank and fuel lines for leaks. Any fuel leak is a fire hazard. Fix any fuel leaks before starting engine. -During transportation take precautions to make sure pressure washer will not tip over and cause a fuel leak fire hazard.</p>
	<p>4.) Poisonous gas. This machine gives off carbon monoxide, a poisonous gas that can kill you. You CANNOT smell it, see it, or taste it. -ONLY run machine outdoors and away from air intakes. -NEVER run machine inside homes, garages, sheds, or other semi-enclosed spaces. These spaces can trap poisonous gases, EVEN IF you run a fan or open doors and windows. If you start to feel sick, dizzy, or weak while using this machine, shut it off and get to fresh air RIGHT AWAY. See a doctor. You may have carbon monoxide poisoning.</p>

figD1472

Save These Instructions

▲ Important Safety Rules

▲ WARNING



5.) Risk of exposure to dangerous chemicals.

Serious injury or death can result if chemical manufacturer instructions are not followed.

- Wear protective gloves when handling and cleaning with chemicals.
- Understand all safety hazards and first aid for all chemicals being used.
- When cleaning filters, check if chemicals have been used and take any precautions that are recommended by the chemical manufacturer.
- Different chemicals may interact dangerously with each other, always follow chemical manufacturer directions before switching chemicals.
- Calculate the correct amount of chemical to mix, dispose of excess chemical per the manufacturer instructions.
- Never spray flammable liquids.



6.) Risk of electrocution.

Electricity can kill you. Keep water away from electrical outlets and electrical devices.



7.) Flying objects.

Small particles may fly out while spraying. Wear safety glasses. Serious eye injury can occur.

Make sure nozzle is secure before squeezing trigger. If nozzle is not secure it will become a projectile.



8.) Fall hazard.

Pressure washer creates puddles and slippery surfaces. Keep good footing and balance. Serious injury can occur.

- Wear footwear capable of maintaining a good grip on wet surfaces.
- Gun kicks back. Hold with both hands.
- Do not overreach or stand on unstable supports.
- Do not stand on ladders or scaffolding.
- Do not place pressure washer on soft or unstable ground.



▲ CAUTION

1.) Hot muffler.

You can be burned by muffler. Do not touch.

fig01546

Save These Instructions

▲ Warning Label Locations

▲ WARNING

1.) Skin puncture hazard. Do not direct spray at people or animals. Seek IMMEDIATE surgical treatment.

2.) Risk of fire and explosion. Do not add fuel when engine is running or still hot.

3.) Breathing hazard. Poisonous fumes from engine can kill you. Do not operate indoors even if ventilated.

4.) Risk of electrocution. Keep water away from electric outlets and electric devices.

5.) Read owner's manual. Serious injury or death can result if safety instructions are not followed.

©2003 K-Bar Industries 800-270-0810 Part No. 38570

Call 1-800-270-0810 to order new labels.
Instruction Label: Part No. 32538
Warning Label: Part No. 38570 (includes hot muffler caution located on engine)

START-UP INSTRUCTIONS

1. Attach garden hose.
2. Attach pressure hose.
3. Attach gun and lance.
4. Turn water supply ON.
5. Squeeze trigger to purge air from pump.
6. Insert nozzle.
7. Start engine.

SHUT-DOWN INSTRUCTIONS

1. Turn engine OFF.
2. Turn water supply OFF.
3. Squeeze trigger to relieve system pressure.
4. Remove garden hose.
5. Remove pressure hose.
6. Turn fuel valve OFF (if equipped).



Engine and pump not shown for clarity.

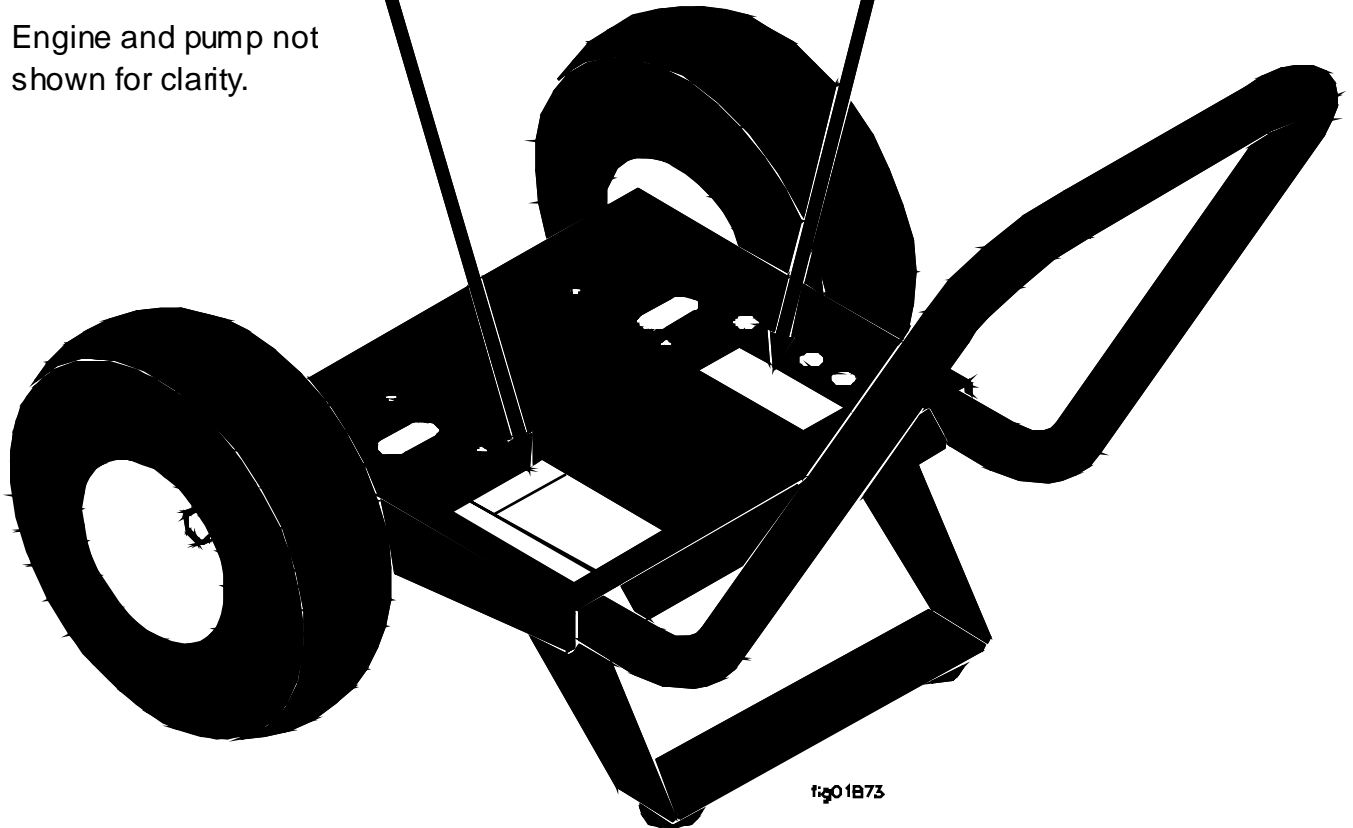

▲ Assembly Instructions

I.) Unpack

Your pressure washer is shipped in two boxes. Separate and identify the components found in both boxes.

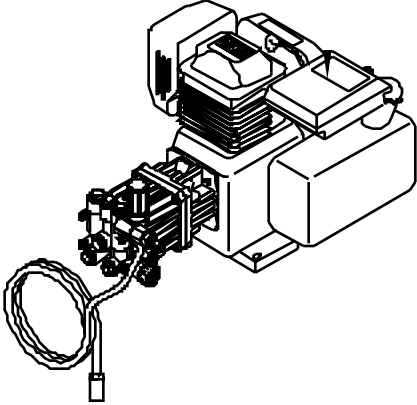
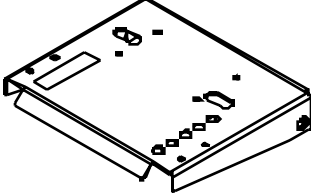
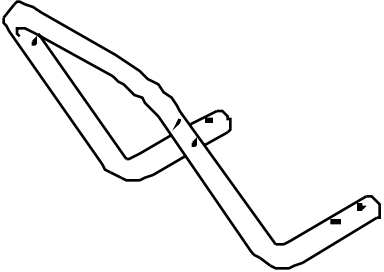
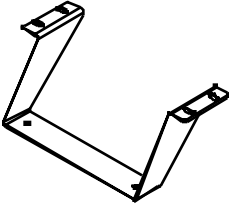
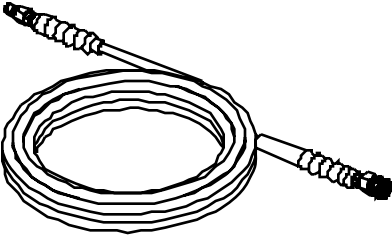
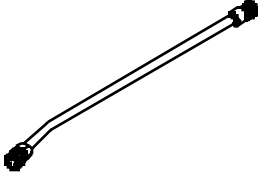
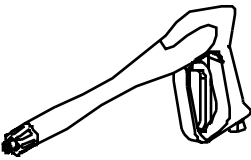
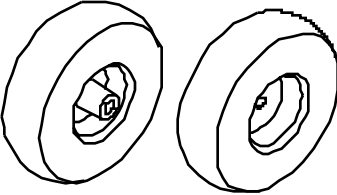
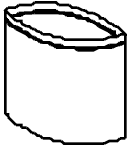
 <p>Engine/ Pump assembly</p>	 <p>Base</p>	 <p>Handle</p>
 <p>Leg</p>	 <p>Pressure Hose</p>	 <p>Lance</p>
 <p>Spray Gun</p>	 <p>Wheels</p>	 <p>Hardware Bag</p>

Any Questions, Comments, Problems or Parts Orders

Call Northstar Customer Service 1-800-270-0810

▲ Assembly Instructions

II.) Hardware Bag

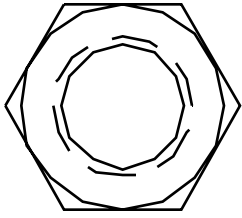

3/4" Nut
Qty - 4

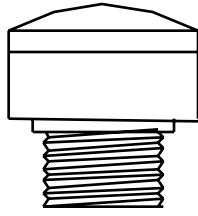

Vented fill cap
Qty - 1

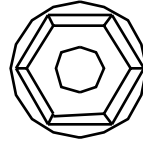

5/16" Nut
Qty - 16

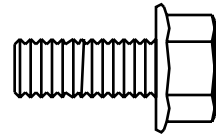

5/16" x 3/4" Bolt
Qty - 2

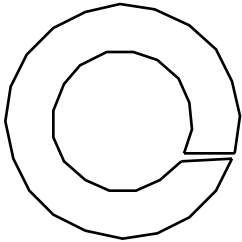

3/4" Lock washer
Qty - 2

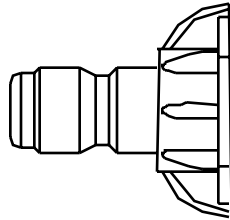

Nozzle
Qty - 2

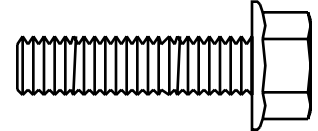

5/16" x 1 1/2" Bolt
Qty - 4

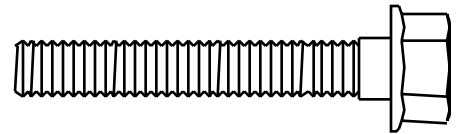

5/16" x 2" Bolt
Qty - 4

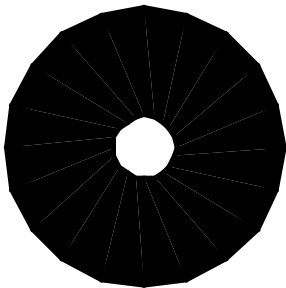

Rubber foot
Qty - 2

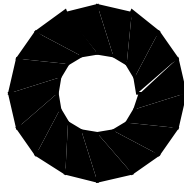

Grommet
Qty - 5

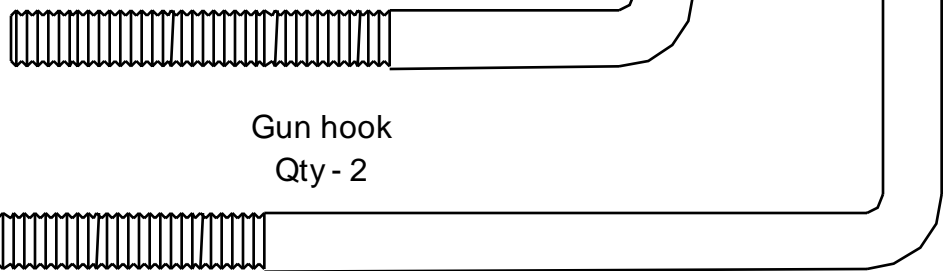

Gun hook
Qty - 2

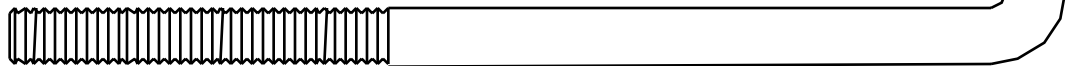

Hose hook
Qty - 1

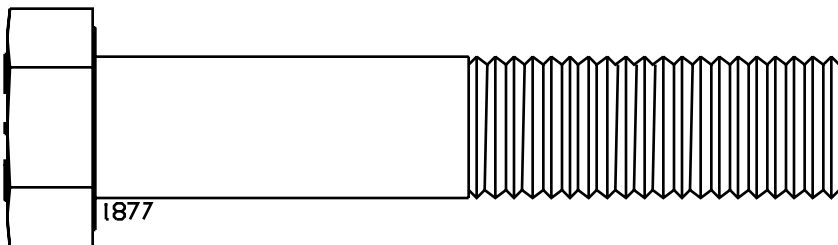

3/4" x 4" Bolt
Qty - 2

▲ Assembly Instructions

III.) Cart Assembly

Step 1.) Fasten rubber feet onto leg with wrench.

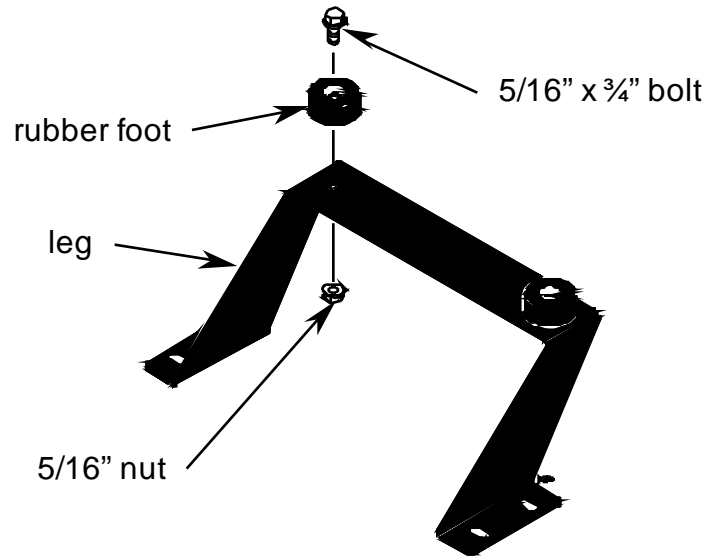

Step 2.) Fasten leg with feet and handle to base with wrench.

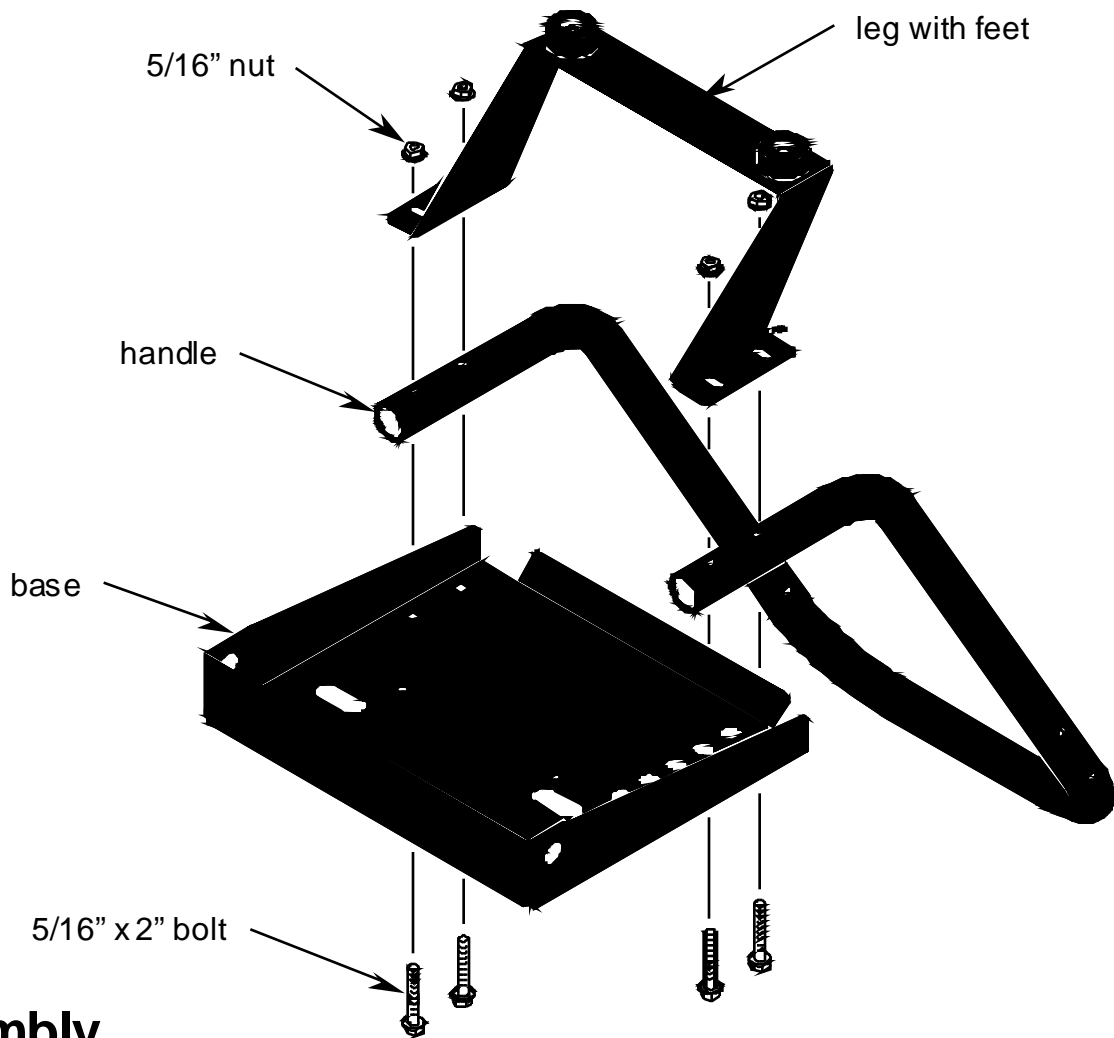

▲
Assembly

Instructions

Step 3.) Slide $\frac{3}{4}$ " x 4" bolt through wheel and fasten with $\frac{3}{4}$ " nut hand tight.

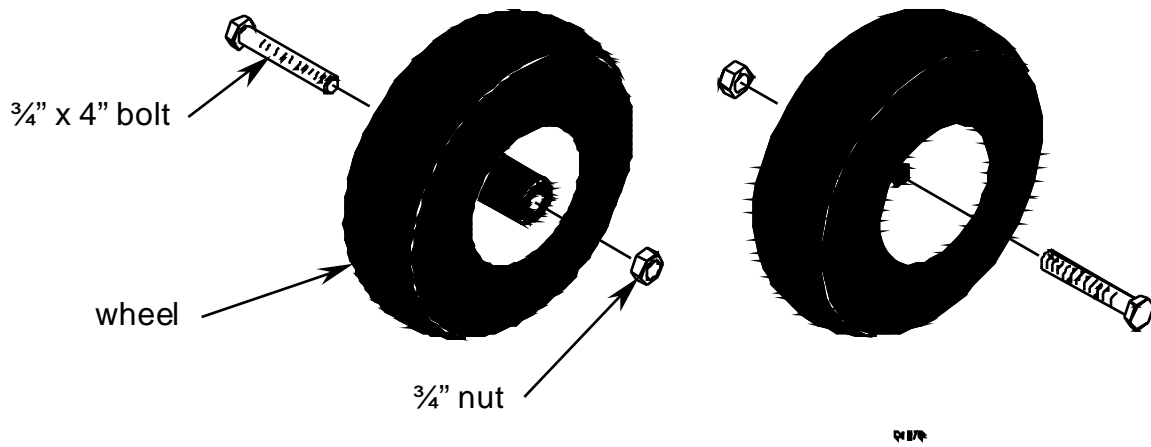

Step 4.) Fasten wheel assemblies to base with wrench. Check that wheels turn freely.

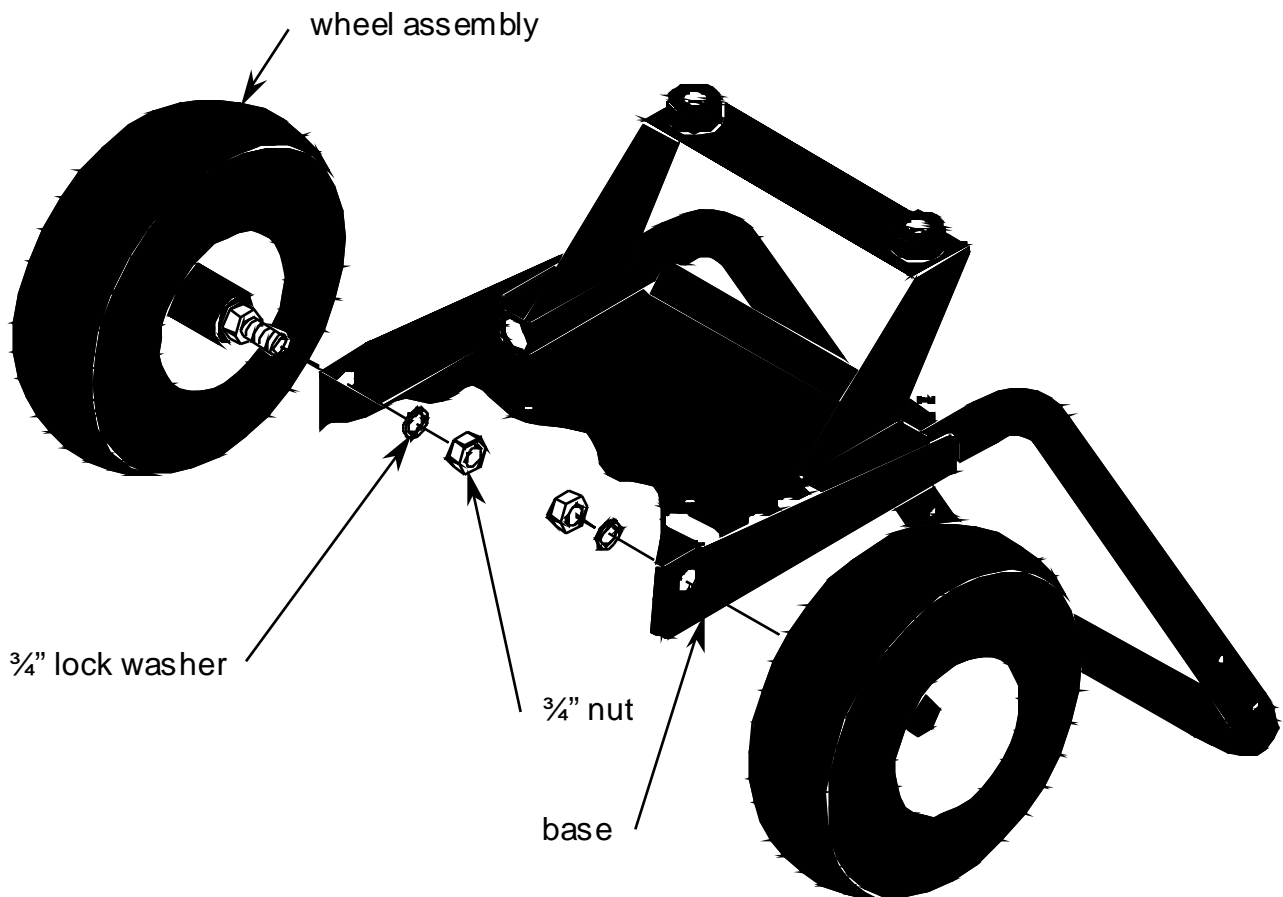

▲ Assembly instructions

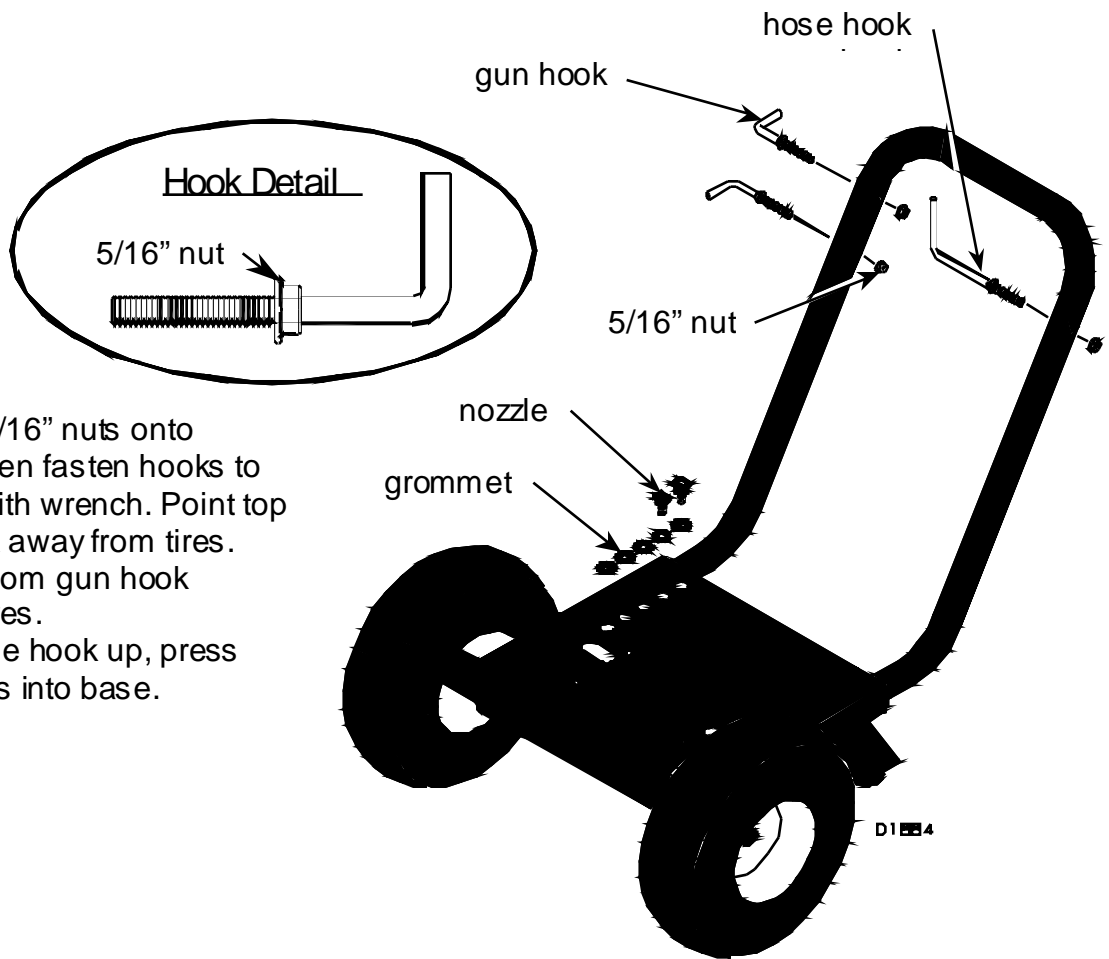

Step 5.) Thread 5/16" nuts onto hooks, then fasten hooks to handle with wrench. Point top gun hook away from tires. Point bottom gun hook toward tires. Point hose hook up, press grommets into base.

Step 6.) Fasten engine to base with wrench.

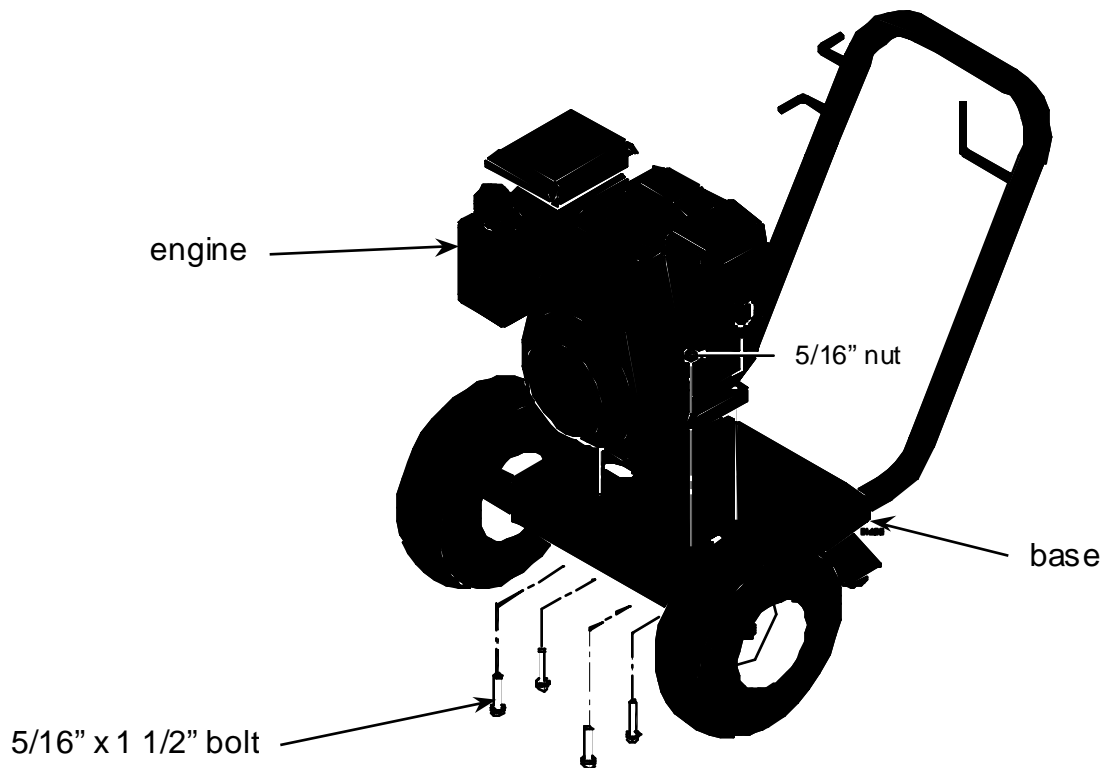

Machine Component Identification

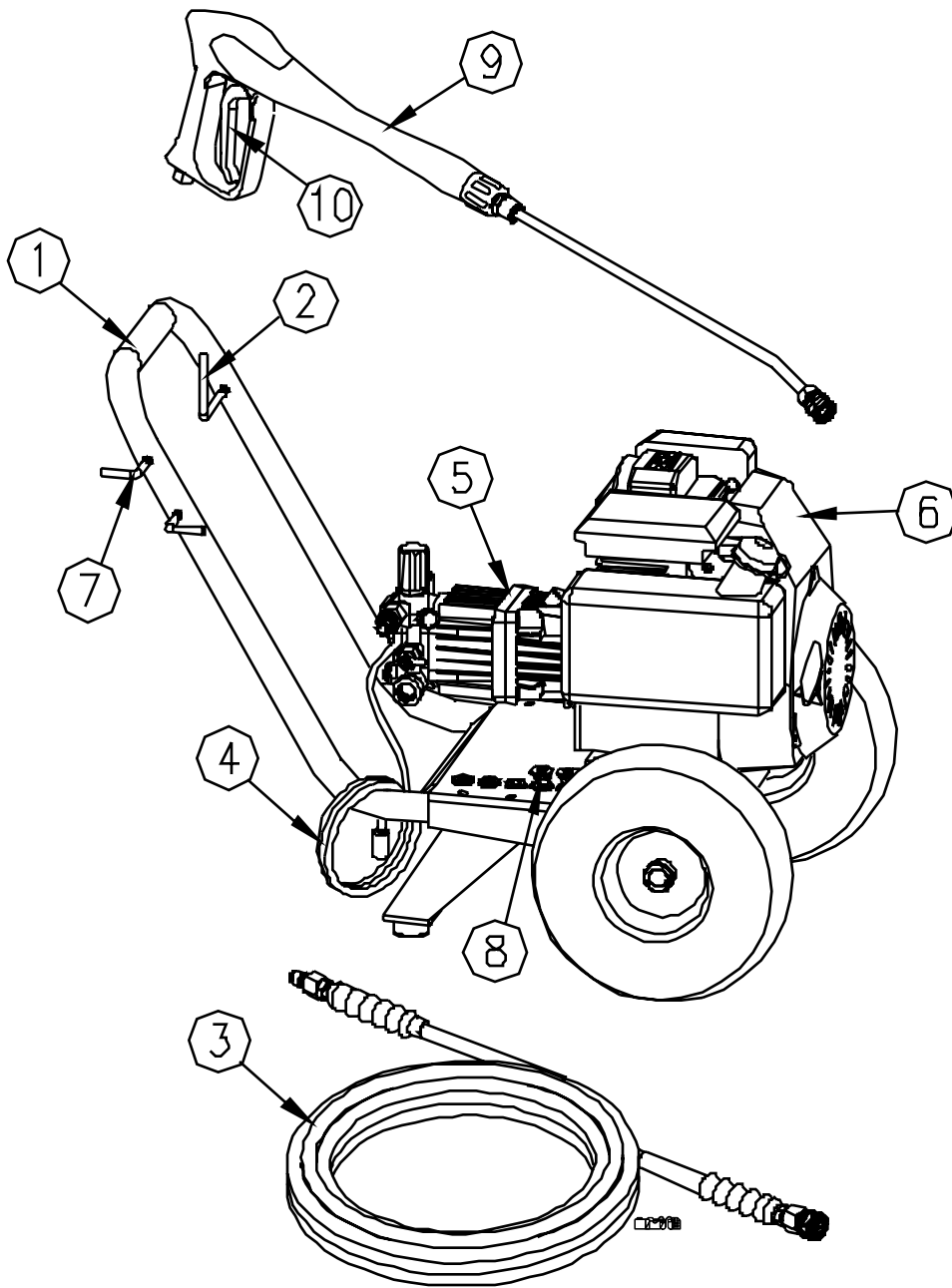

- 1.) **Handle.** Designed for easy cart movement.
- 2.) **Hose Hook.** Store pressure hose on hook.
- 3.) **Pressure Hose.** Attach quick couplers to gun and water outlet.
- 4.) **Chemical Hose.** Submerge in cleaning solution.
- 5.) **Water Pump.** Inspect for loose/broken parts prior to each use.
- 6.) **Engine.** Honda engine provides years of reliable use.
- 7.) **Gun Hook.** Store gun here.
- 8.) **Nozzles.** Change nozzles for different spray patterns
- 9.) **Spray Gun.** Always use two hands for safe operation.
- 10.) **Trigger.** Actuate to allow pressurized water to flow out of spray gun.

Pump Oil Cap and Pump Component Identification

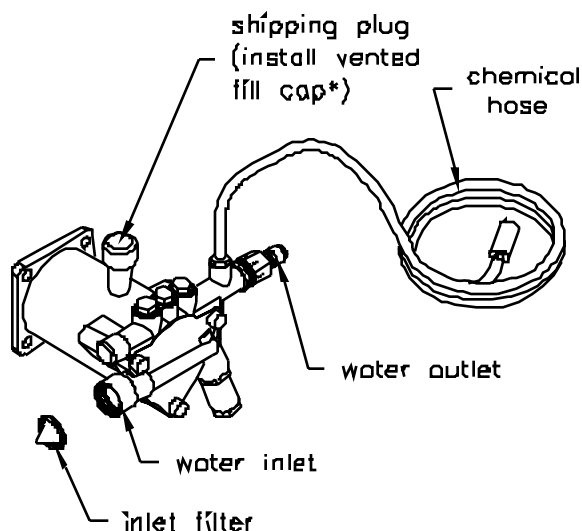

1577541

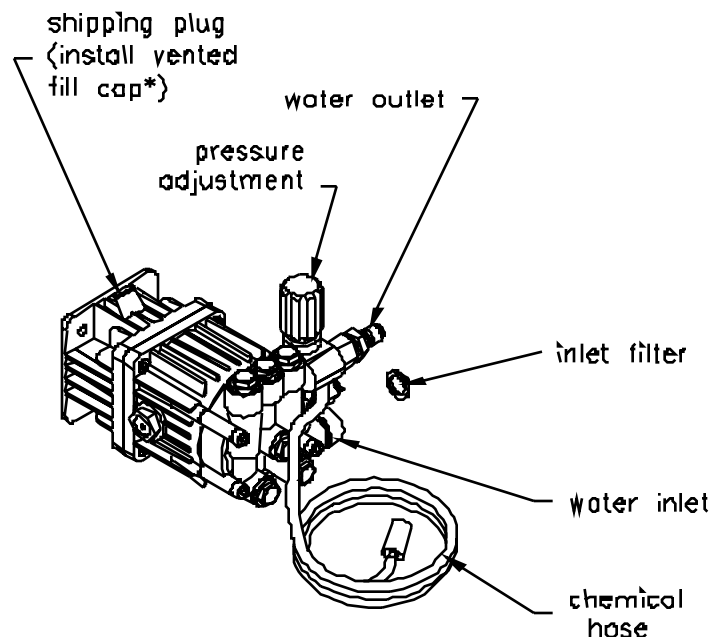

1577542

*Note: Discard shipping plug and o-ring.

▲ Operation Instructions

Water Supply

- 1.) Make sure the water supply is clean. Debris can cause excess pump wear and reduce performance.
- 2.) An insufficient water supply will damage your pump. Make sure the water supply is steady and is 20% over the rated flow of your pump. Use a stopwatch to time how long it takes to fill a 5 gallon bucket with your garden hose. The bucket must be filled faster than 100 seconds.
- 3.) The water supply garden hose must have an inside diameter of at least 5/8". If the hose is more than 100 ft. long, the diameter must be at least 3/4".
- 4.) Never use a reservoir tank as a water source. Drawing water out of a tank may cause pump cavitation and damage to your pump. This pressure washer is designed for a pressurized water source such as a city water faucet. However, the water source pressure must not exceed 115 psi (8 bar).
- 5.) Always use a flexible rubber hose for your water supply. Do not use rigid piping.

▲ Operation Instructions

Start-Up Instructions

1. Attach garden hose to water inlet.
2. Attach pressure hose to water outlet and gun.
3. Attach spray gun to lance.
4. Turn water supply ON.
5. Squeeze trigger to purge air from pump.
6. Insert nozzle.
7. Start engine.

Shut-Down Instructions

1. Turn engine OFF.
2. Turn water supply OFF.
3. Squeeze trigger to relieve system pressure.
4. Remove garden hose.
5. Remove pressure hose.

▲ WARNING	
	<p>Skin puncture hazard.</p> <p>High pressure fluid can inject under skin resulting in serious injury including amputation. Do not direct spray at people or animals.</p> <ul style="list-style-type: none">-If skin injection happens, seek IMMEDIATE surgical treatment.-Do not check for leaks with hand. Instead, use a piece of cardboard to check for leaks.-Do not use unit if exterior hose damage is evident. Make sure all fittings are tight before starting. Relieve system pressure before servicing.-Know how to stop engine and bleed pressures quickly. Be thoroughly familiar with the controls.-Make sure accessories meet the unit's temperature and pressure limits.-Stop engine and bleed pressures before leaving unit unattended.

fig01863

▲ Operation Instructions

Spray Gun Safety Lock

When not spraying, use the spray gun safety lock to prevent accidental high pressure discharge.

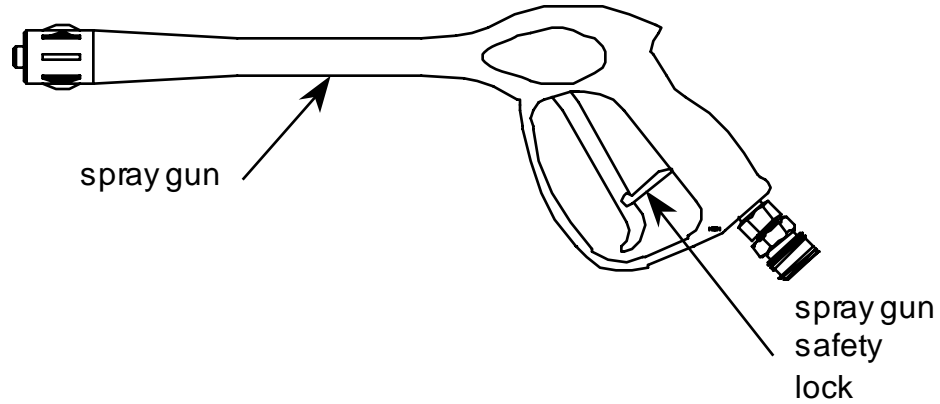

Attaching the Lance

Tighten spin-on coupler hand tight.

Note: The o-rings make the seal so there is no need to tighten with a wrench.

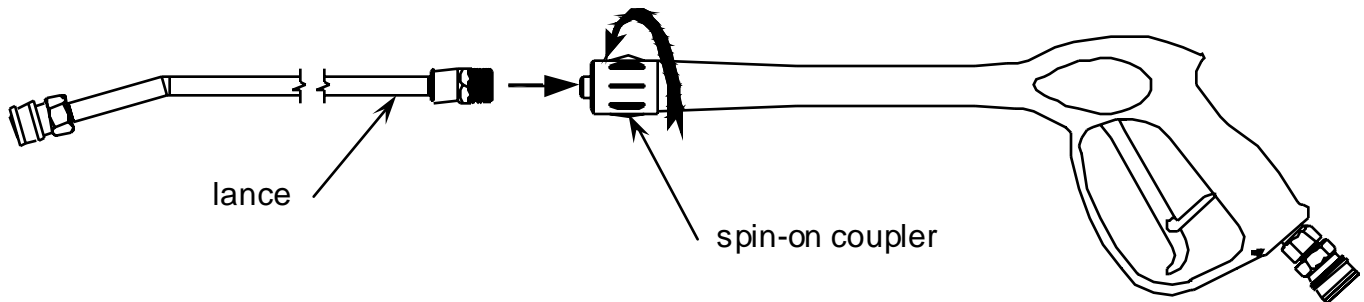

▲ Operation Instructions

Installing Nozzles

To install a nozzle pull back the collar and push the nozzle into the coupler. Once the connection is made, pull on the nozzle to make sure it is secure.

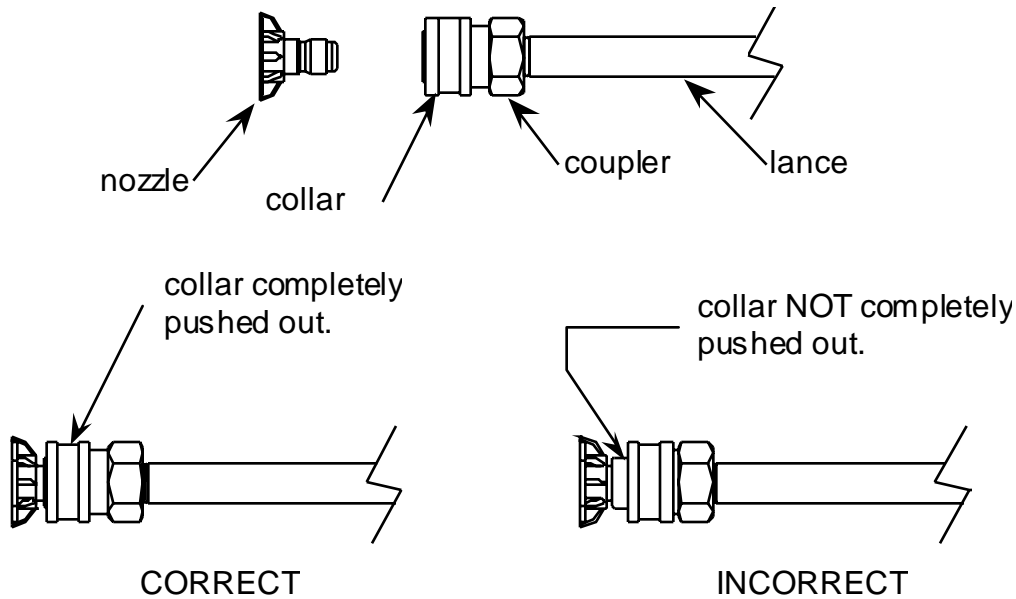

▲ WARNING

Flying objects.

Make sure nozzle is secure before squeezing trigger. If nozzle is not secure it will become a projectile. Serious injury can occur.

fig 01B64

Attach Quick Connect Couplers

-To install the hose onto the pump, pull back the collar and push the hose into the coupler on the pump. Then push the collar completely out.

-To install the hose onto the spray gun, pull back the collar on the spray gun and push the hose into the coupler on the spray gun. Then push the collar completely out.

Once the connections are made, pull on the hose to make sure it is secure.

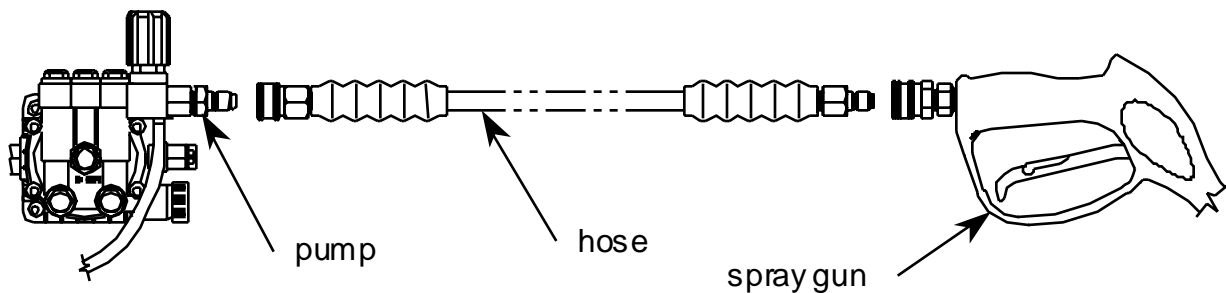

▲ Operation Instructions

Applying Chemicals

- 1.) Install the black nozzle to spray chemicals onto the cleaning surface.
- 2.) Start the pressure washer according to the start-up instructions.
- 3.) Submerge the chemical hose in cleaning solution.
- 4.) Squeeze the spray gun trigger. The chemical injector will draw the chemical into the water stream.
- 5.) Apply chemicals evenly onto the cleaning surface. Allow the chemicals to react with the dirt, then clean at high pressure with green nozzle.
- 6.) Never use more chemical than is necessary to clean the surface.
- 7.) Rinse chemical injector by following steps 1 through 4 with clean water.

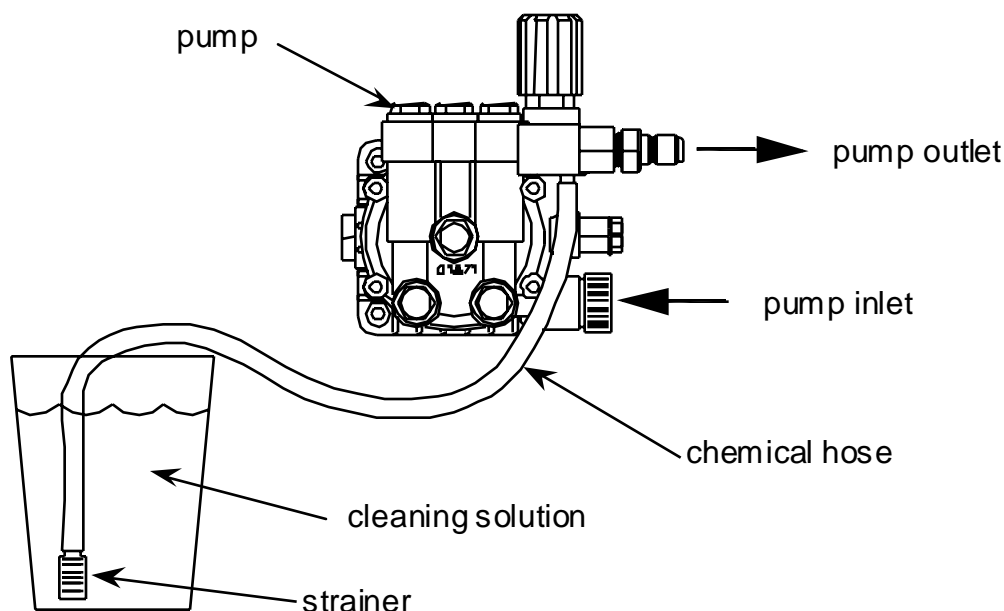

▲ WARNING

Risk of exposure to dangerous chemicals.

Serious injury or death can result if chemical manufacturer instructions are not followed.

- Wear protective gloves when handling and cleaning with chemicals.
- Understand all safety hazards and first aid for all chemicals being used.
- When cleaning filters, check if chemicals have been used and take any precautions that are recommended by the chemical manufacturer.
- Different chemicals may interact dangerously with each other, always follow chemical manufacturer directions before switching chemicals.
- Calculate the correct amount of chemical to mix, dispose of excess chemical per the manufacturer instructions.
- Never spray flammable liquids.



figD1.845

▲ Maintenance

Maintenance Mode

Before performing any maintenance on the pressure washer, it must be placed in maintenance mode.

- 1.) Turn off engine.
- 2.) Turn off water supply.
- 3.) Squeeze trigger to relieve system pressure.
- 4.) Unplug spark plug wire from spark plug, (see engine owners' manual).

Maintenance Schedule

What to Check	When To Check	What to Do
Inlet Filter	Each Use	Visually inspect and clean inlet filter with clear water.
Pressure Hose	Each Use	Visually inspect pressure hose and hose couplings. Replace hose if any of the following is evident: hose coupling is damaged, wire mesh is exposed or damaged, hose is permanently kinked or flattened, outer hose cover is blistered or loose.
Bolts	Each Use	Tighten any loose bolts.
Engine Oil	See engine manual	See engine manual for oil change instructions
Pump Oil	After 1 st 50hrs, then 3mo/500hr	Change pump oil. See pump oil change instructions.

	▲ WARNING
	Skin injection hazard. High pressure fluid can inject under skin resulting in serious injury including amputation. -Make sure all fittings are tight before applying pressure. Relieve system pressure before servicing. -Do not check for leaks with hand. Instead, use a piece of cardboard to check for leaks. -If skin injection happens, seek immediate "Surgical Treatment".

Fig 1154

▲ Maintenance

Pump Oil Change

- 1.) Place a suitable container below the pump to catch the used oil, then remove the oil fill cap and oil drain plug.
- 2.) Allow the used oil to drain completely, then reinstall the drain plug, and tighten securely.
- 3.) Please dispose of used oil in a manner that is compatible with the environment. We suggest you take used oil in a sealed container to your local recycling center or service station for reclamation. Do not throw it in the trash, pour it on the ground, or down the drain.
- 4.) With the pump in a level position add oil to the pump, (see capacities below). Use Universal Tractor Transmission Oil (part #COCP2101) or Mobil 1 15W50 synthetic oil.

1577541
Comet VRX Pump

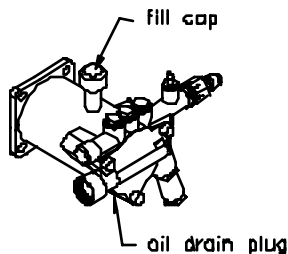

Oil capacity: 3.4 oz. (.10L)

1577542
Comet AXD Pump

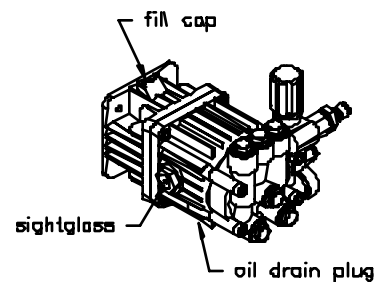

Oil capacity: 5.7 oz. (.17L)

▲ Storage

Long Term Storage

Follow the engine owner's manual for storing the engine.

Winter Storage

Protect your pump, hose, and gun from freezing.
Items needed: 12" piece of garden hose or equivalent, funnel and RV antifreeze (approximately 6 oz.)

- 1.) Follow the storage instructions listed above.
- 2.) Disconnect spark plug cable. Make sure the engine start switch is OFF, and the fuel valve is OFF.
- 3.) Attach the garden hose with funnel to the pump inlet (see illustration).
- 4.) Pour RV antifreeze into the funnel, pull the engine recoil until antifreeze comes out the pump outlet.
- 5.) Drain all water from the high pressure hose. Depress trigger on gun and drain all water out of gun/lance.

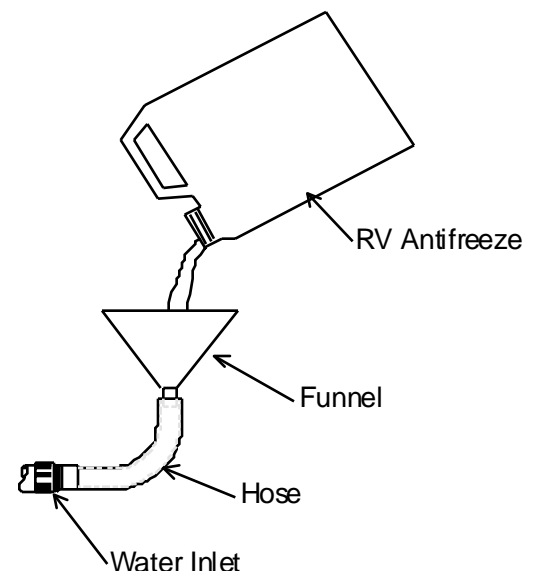

Troubleshooting

Problem	
Engine will not start	SOLUTION: A
Low/Surging pressure or no water flow	SOLUTION: B,C,D,E,F,G
No chemical injection	SOLUTION: H,I,J,K
Cause	Solution
A- Engine starting instructions not followed	See engine manual for starting instructions
B- Insufficient water supply	See water supply section of this manual
C- Plugged pump inlet filter	See maintenance section of this manual
D- Wrong nozzle	Make sure high pressure nozzle is being used
E- Plugged nozzle	Remove nozzle, check for blockage
F- Worn nozzle	Replace nozzle
G- Leak in pressure hose	Replace pressure hose
H- Wrong nozzle	Make sure chemical nozzle is being used
I- Back pressure from extra long pressure hose	Use standard length hose
J- Leak in chemical siphon hose	Replace hose – use hose clamps if necessary
K- Chemical strainer not submerged	Make sure strainer is completely submerged

Specifications

1577541

PSI (bar)	2600 (179)
GPM (l/min)	2.5 (9.4)
Max Water Temp	140°F (60°C)
Noise Level	75 dB
Dimensions L x W x H	30.5 x 24 x 24.3
Weight	77 lbs

1577542

PSI (bar)	2700 (186)
GPM (l/min)	2.5 (9.4)
Max Water Temp	140°F (60°C)
Noise Level	82 dB
Dimensions L x W x H	30.5 x 24 x 24.3
Weight	83 lbs

The manufacturer reserves the right to make improvements in design and/or changes in specifications at any time without incurring any obligation to install them on units previously sold.

Any Questions, Comments, Problems or Parts Orders

Call Northstar Customer Service 1-800-270-0810

Parts Explosion

Item Numbers:
1577541,
1577542
Revision A

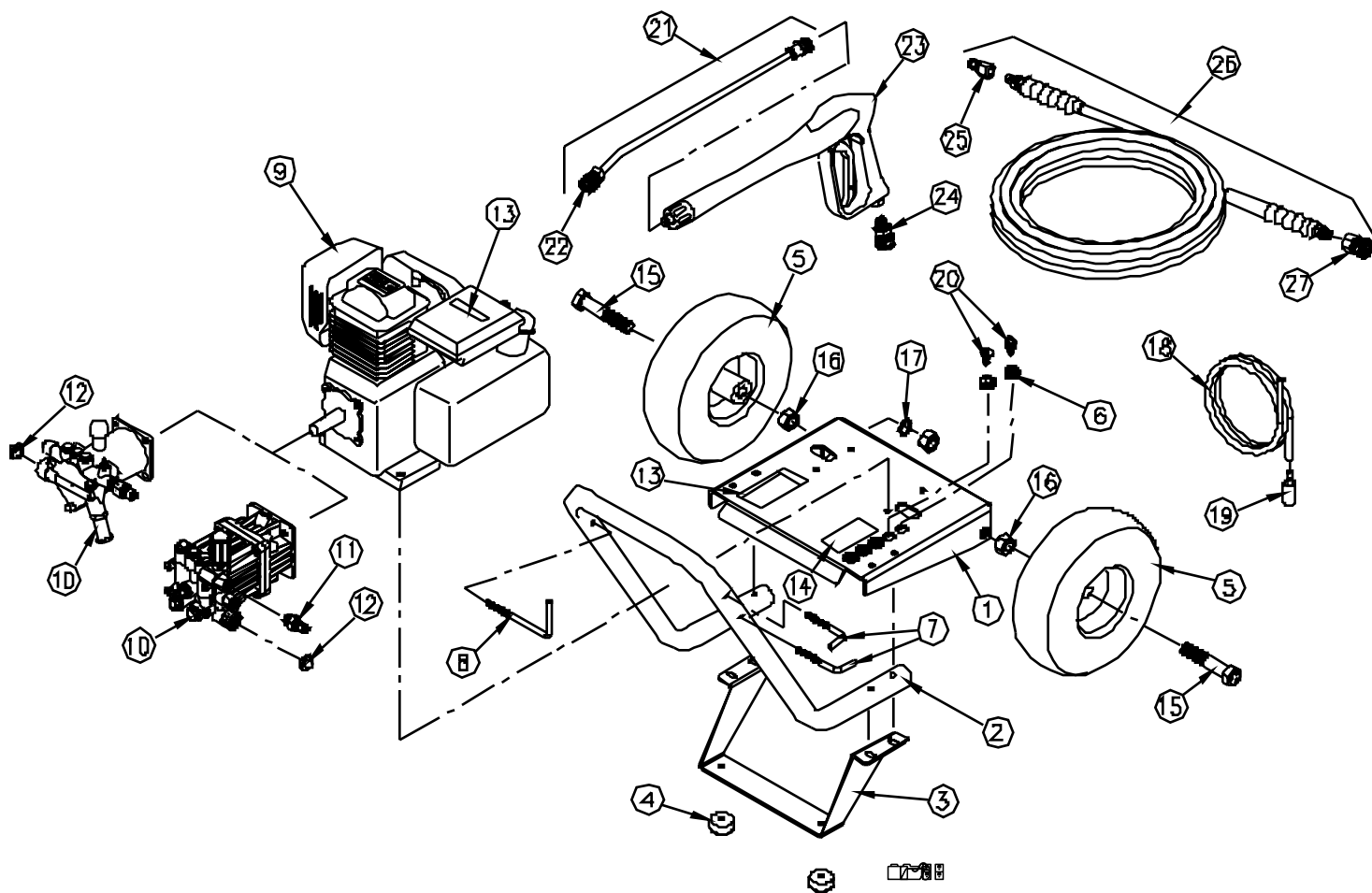

REF#	PART#	DESCRIPTION	QTY	MODEL
1	38569	Base	1	all
2	38573	Handle	1	all
3	38574	Leg	1	all
4	2215	Rubber Foot	2	all
5	2278	Wheel	2	all
6	17156	Grommet	5	all
7	38509	Gun Hook	2	all
8	38510	Hose Hook	1	all
9	60599	Honda GC 160	1	1577541
	68522	Honda GC 190	1	1577542
10	38514	Comet VRX Pump	1	1577541
	38515	Comet AXD Pump	1	1577542
11	313106	QC 3/8 male nipple	1	1577542
12	4027	Filter washer	1	all
13	38570	Warning Decal	1	all

REF#	PART#	DESCRIPTION	QTY	MODEL
14	32538	Instruction Decal	1	all
15	82230	3/4" x 4" Bolt	2	all
16	82040	3/4" Nut	4	all
17	82041	3/4" Lock washer	2	all
18	33488	Chemical hose	3 ft	all
19	2212	Chemical strainer	1	all
20	38530	Nozzle 2 pack, #3.0	1	all
21	31930	Lance	1	all
22	2234	Nozzle quick coupler	1	all
23	38527	Spray gun	1	all
24	313107	Hose quick Coupler	1	all
25	313109	Hose Quick Couple Nipple	1	all
26	38524	5/16" x 25' Gray high pressure hose	1	all
27	313108	Hose quick Coupler	1	all